

PILLAR CAPS SHEET 1 - LAST REVISION 1/6/21

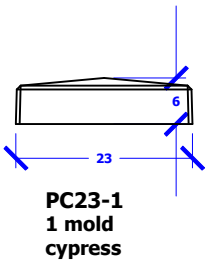

882 N. Marshall Way
 Layton, UT 84041
 Ph. (801) 544-9054
 Fax: (801) 544-9154

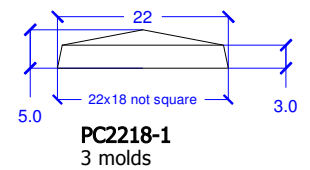
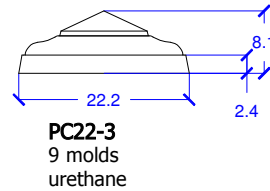
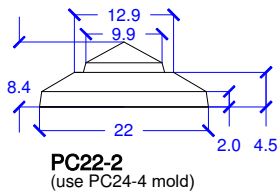
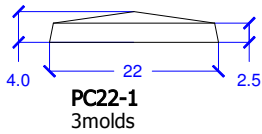
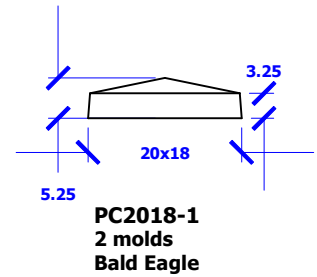
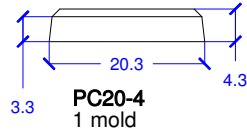
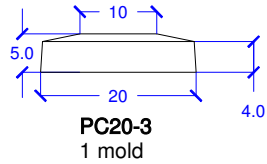
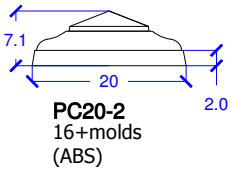
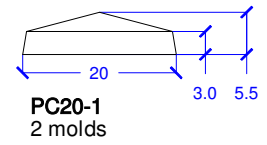
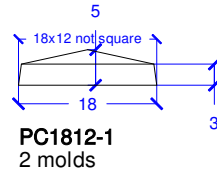
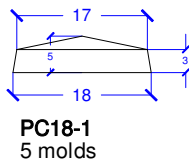
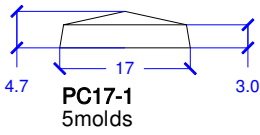
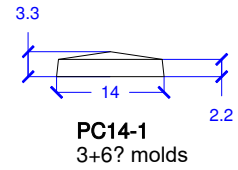
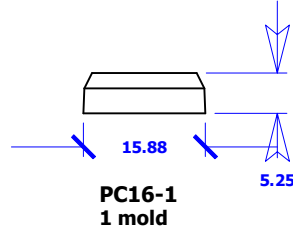
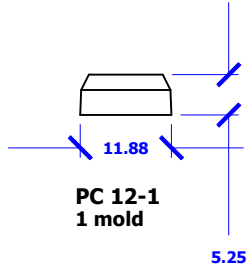
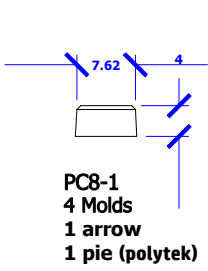

PILLAR CAPS SHEET 2 - LAST REVISION 1/6/21



882 N. Marshall Way
Layton, UT 84041
Ph. (801) 544-9054
Fax: (801) 544-9154

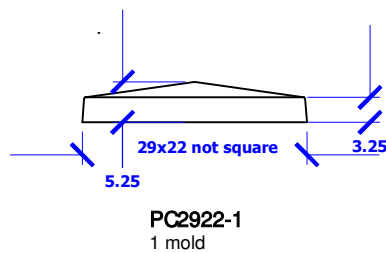
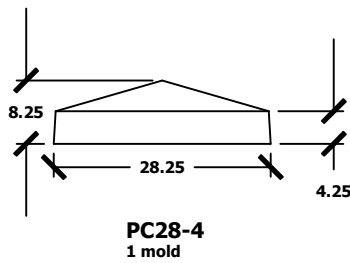
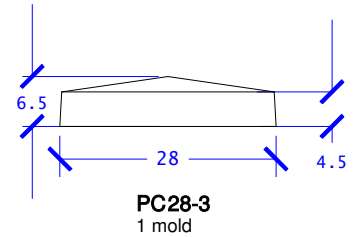
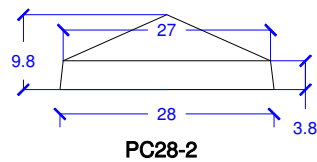
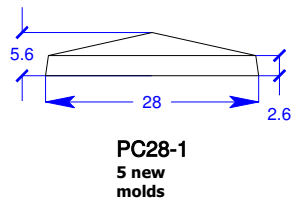
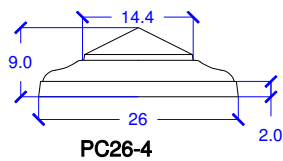
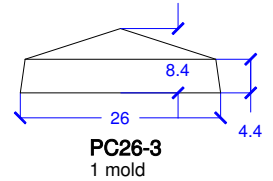
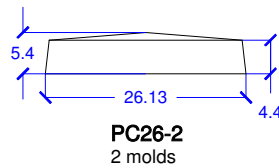
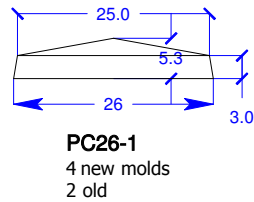
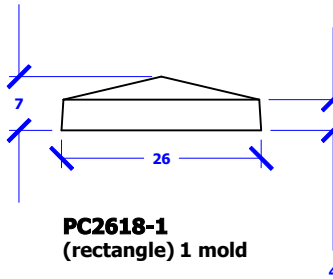
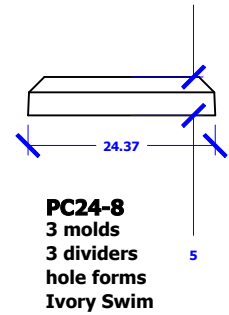
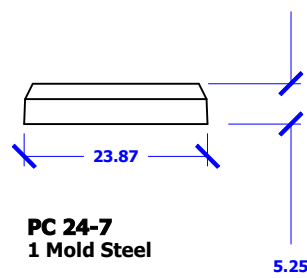
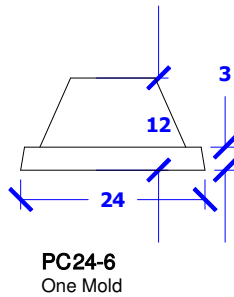
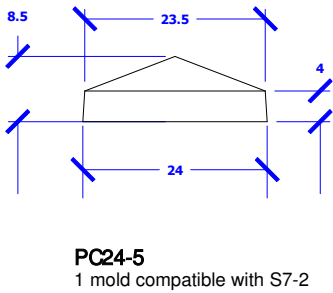
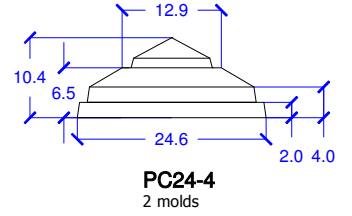
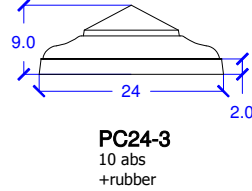
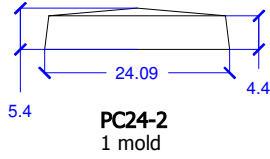
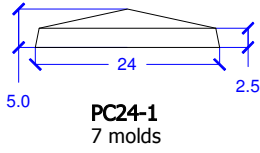

PILLAR CAPS SHEET 3 - LAST REVISION 1/6/21



882 N. Marshall Way
Layton, UT 84041
Ph. (801) 544-9054
Fax: (801) 544-9154

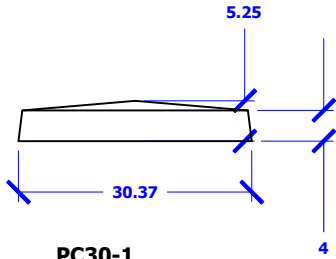

PC30-1
1 mold
Foxboro North

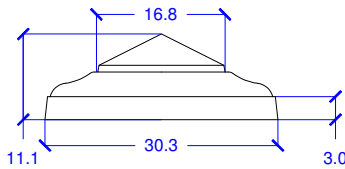

PCT30-1
1 mold

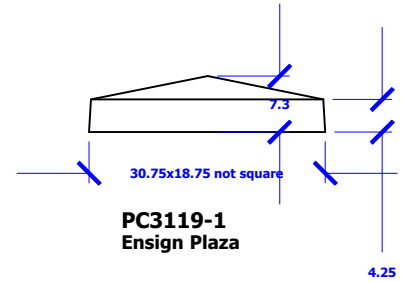

PC3119-1
Ensign Plaza

4.25

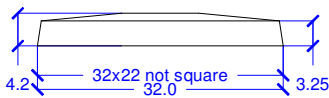

PC3222-1
1 mold

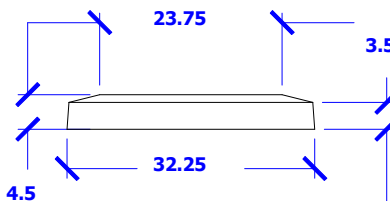

PC32-2
1 mold

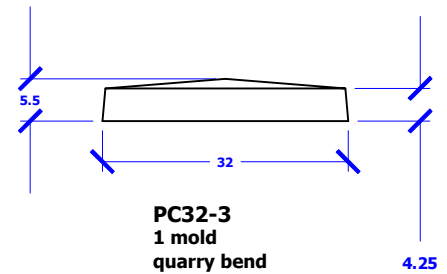

PC32-3
1 mold
quarry bend

4.25

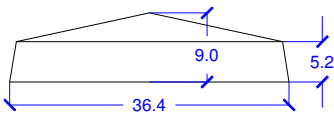

PC36-1
1 mold

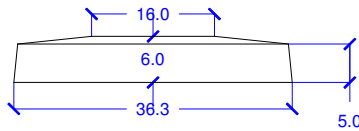

PC36-2
1 mold

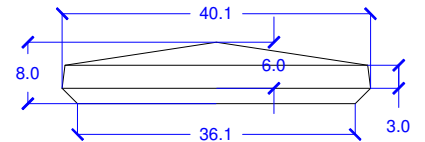

PC36-3
1 mold

3.0

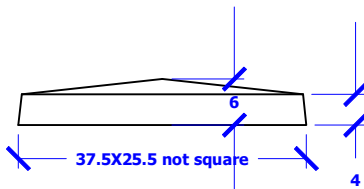

PC3725-1
1 mold

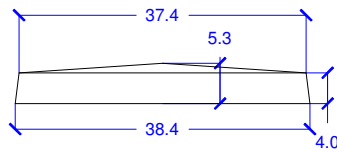

PC38-1
1 mold

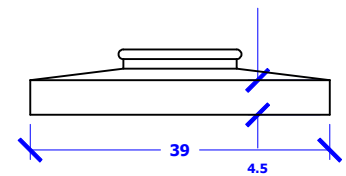

PC39-1
1 mold
Ivory Highlands

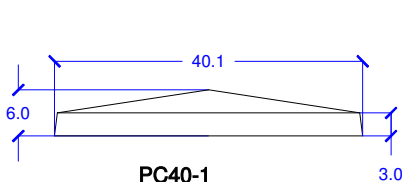

PC40-1
Use PC36-3 mold

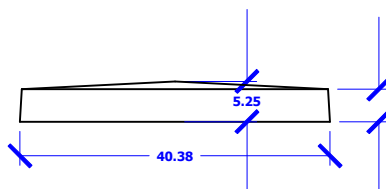

PC40-2
2 molds
W40-1 compatible
Condos at the Canyons

4.25

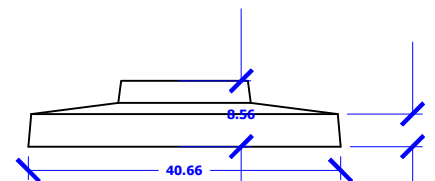

PC41-1
This mold is Mother for
PC39-1

4.25

PILLAR CAPS SHEET 4 - LAST REVISION 1/6/21



882 N. Marshall Way
Layton, UT 84041
Ph. (801) 544-9054
Fax: (801) 544-9154

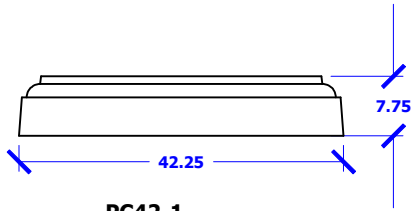

PC42-1
1 mold
Ivory Highlands

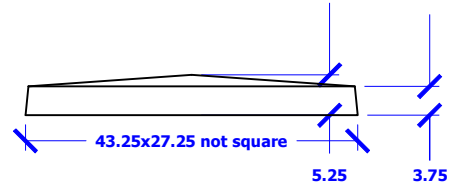

PC4327-1
not square
1 mold

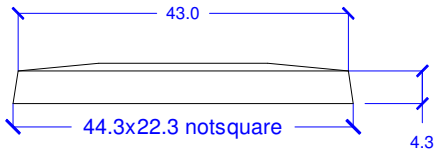

PC4422-1
1 mold

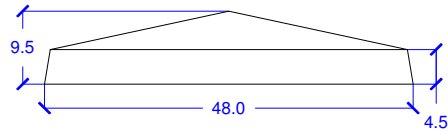

PC48-1
1 mold

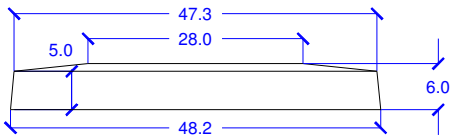

PC48-2
1 mold

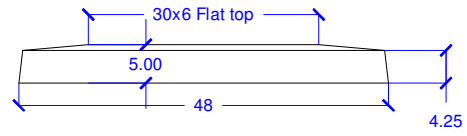

PC4824-1
not square
1 mold

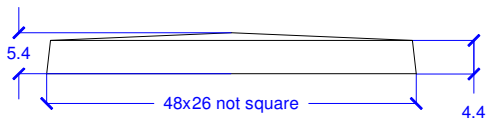

PC4826-1
1 mold

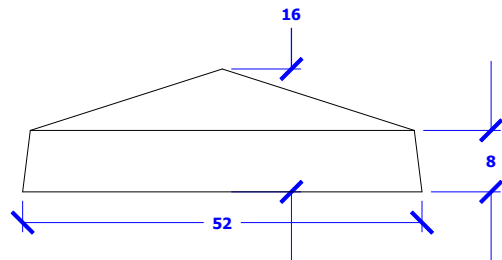

PC52-1
1 mold

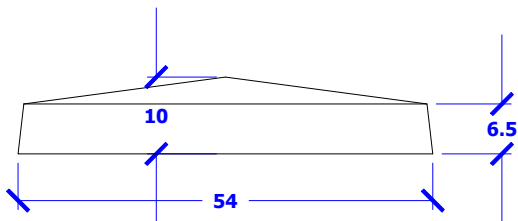

PC54-1
1 mold

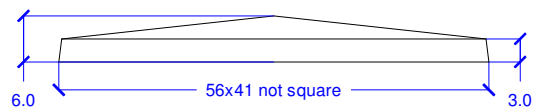

PC5641-1
1 mold

PILLAR CAPS SHEET 5 - LAST REVISION 7/18/07



882 N. Marshall Way
Layton, UT 84041
Ph. (801) 544-9054
Fax: (801) 544-9154

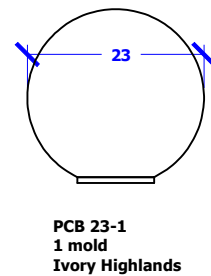
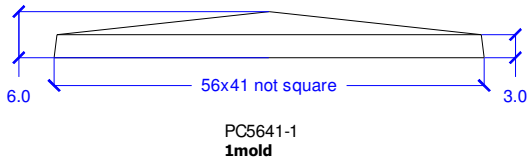
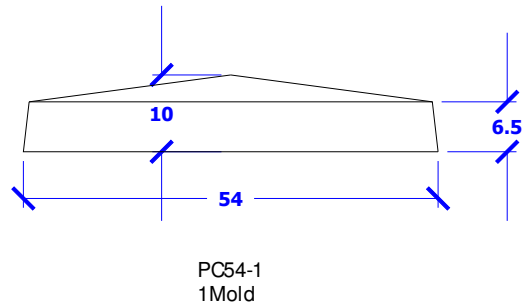
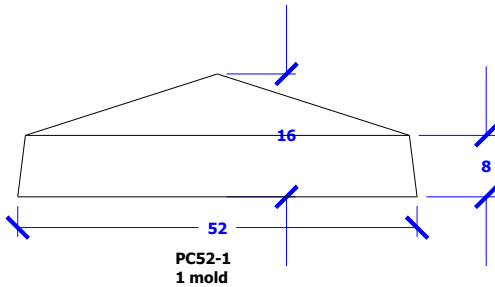
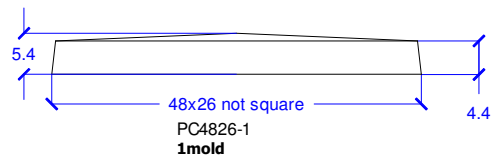
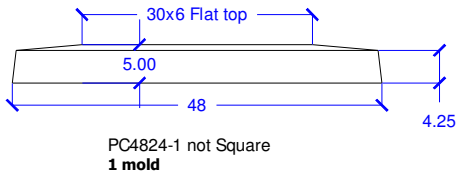
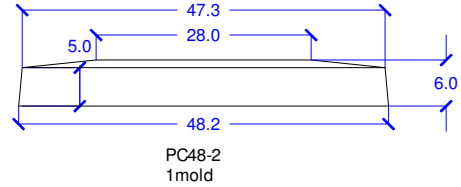
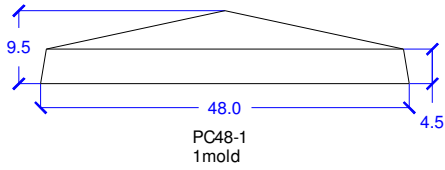

PILLAR CAPS SHEET 6 - LAST REVISION 7/18/07



882 N. Marshall Way
Layton, UT 84041
Ph. (801) 544-9054
Fax: (801) 544-9154

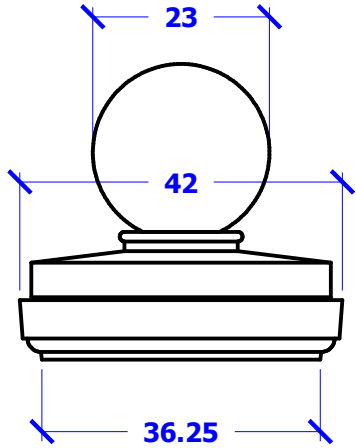

Example:
PCB23-1 Top Ball
PC39-1 Full Thick Base Under Ball
PC42-1 Full Thick Lower Base
These Molds used for Ivory Highlands in Taylorsville